



Estd. 1954

প্রাগজ্যোতিষ মহাবিদ্যালয়

PRAGJYOTISH COLLEGE

Accredited by NAAC with B Grade (3rd Cycle), under Revised Accreditation Framework (RAF)

Annual Quality Assurance Report (AQAR)

2022-2023

CRITERIA 2.3.2

EFFECTIVE TEACHING-LEARNING USING ICT TOOLS

Submitted to



THE NATIONAL ASSESSMENT AND ACCREDITATION COUNCIL



PRAGJYOTISH COLLEGE

(Affiliated to Gauhati University and recognized under Sections 2(f) and 12(B) of the U.G.C. Act, 1956)

Santipur, Guwahati – 781009, Assam

E-mail: principal@pragjyotishcollege.ac.in Website: www.pragjyotishcollege.ac.in

College administration encourages teachers by providing financial and duty leave grants to participate in training/FDP/refreshers course related to teaching-learning with ICT

**INTERNAL QUALITY ASSURANCE CELL
PRAGJYOTISH COLLEGE**
(ESTD: 1994, NAAC ACCREDITED (2004-09, 2011-14, 2021-24), A-COMMENDED UNDER SECTIONS 2(f) AND 12(B) OF UGC)
 Guwahati – 781009, Assam, India
<https://pragjyotishcollege.ac.in/>

Dr. Namita Das
Co-ordinator

Dated Santipur, the 25th August, 2023

Respected Principal Sir,

The IQAC has found the applications of the following teachers who (have requested for providing financial support for attending conferences to present their research work) satisfactory.

Serial No.	Name	Department	Registration Fee (in Rupees)
1.	Seema Kaur	Zoology	500
2.	Kalyani Devi	Philosophy	500
3.	Namita Das	Economics	500
4.	Laltanzoul Khawbung	English	500
5.	Parmita Chowdhury	Philosophy	500
6.	Samrat Dey	Physics	500
7.	Pranab Jyoti Bhuyan	Physics	500
8.	Ranjan Kalita	Physics	500
9.	Saumar Rajkhowa	Physics	500
10.	Pranita Goswami	Statistics	500
11.	Nandita Borah	Statistics	500
12.	Masum Ahmed	Economics	500
13.	Bidyut Bikash Baisya	Economics	500
14.	Ira Das	Economics	500
15.	Sangeeta Das	Zoology	2500
16.	Dr. Seemashree Bora	Zoology	2500

Therefore, I request you to kindly refund the amount.

Thanking you

Namita Das
Passed for payment as financial assistance to faculty members to attend conferences of NAAC.
25/08/2023
 Dr. Namita Das
 Coordinator, IQAC
 Pragjyotish College
 Guwahati-781009

E-mail: coordinatoriqac@pragjyotishcollege.ac.in
 Phone: +91 9201991527, +91 9435306773

Sl. No.	Name of Faculty	Department	Amount	Receiver's Signature
1	Seema Kaur	Zoology	500	<i>[Signature]</i> 23/9/23
2	Kalyani Devi	Philosophy	500	<i>[Signature]</i> 14/9/23
3	Namita Das	Economics	500	<i>[Signature]</i> 21/9/2023
4	Laltanzoul Khawbung	English	500	<i>[Signature]</i> 19/9/23
5	Parmita Chowdhury	Philosophy	500	<i>[Signature]</i> 18/9/23
6	Samrat Dey	Physics	500	<i>[Signature]</i> 15/9
7	Pranab Jyoti Bhuyan	Physics	500	<i>[Signature]</i> 15/9
8	Ranjan Kalita	Physics	500	<i>[Signature]</i> 15/9
9	Saumar Rajkhowa	Physics	500	<i>[Signature]</i> 15/9
10	Pranita Goswami	Statistics	500	<i>[Signature]</i> 15/9/23
11	Nandita Borah	Statistics	500	<i>[Signature]</i> 15/9/23
12	Masum Ahmed	Economics	500	<i>[Signature]</i> 13/9
13	Bidyut B Baisya	Economics	500	<i>[Signature]</i> 13/9
14	Ira Das	Economics	500	<i>[Signature]</i> 13/9
15	Sangeeta Das	Zoology	2500	<i>[Signature]</i> Sangeeta Das 22/9/23
16	Seemashree Bora	Zoology	2500	<i>[Signature]</i> for Sangeeta Das 22/9/23
		TOTAL	12000	

College administration encourages teachers by providing financial and duty leave grants to participate in training/FDP/refreshers course related to teaching-learning with ICT

To,
The Principal
Pragjyotish College
Guwahati-09

Dated: 22/08/2023

Through the HOD, Chemistry

Sub: Application for Duty Leave for Guide Teacher's Training program in connection with 31st NCSC 2023

Sir,

With due respect we have the honor to inform you that as District and Academic Coordinator of Kamrup (M), we are going as Resource Person in the Guide Teacher's Training program in connection with 31st NCSC 2023 to be held in Sonapur H.S. School on 22nd August 2023. Therefore I request you kindly to grant duty leave on this day. We have attached the necessary documents with this application. We will remain grateful to you.

Thanking you.

Regards
Saitanya Kr Bharadwaj
Assistant Professor
Department of Chemistry

Manab Deka
Associate Professor
Department of Physics

Arijit Dutta
Assistant Professor
Department of English

*Deben Deka
Recd. it as DL
Memo No 02/08/2023*

*Deben Deka
Recd. it as DL
Memo No 02/08/2023*

PRAGJYOTISH COLLEGE
GUWAHATI - 781 009, ASSAM

Sl. No. _____

LEAVE APPLICATION OFFICE RECORD

Name of the Employee (in Block Letters): Dr. MANJIT KR. MAZUMDAR

Designation: Associate Professor Department: Geology

Leave Category: CL/DL Others (Please specify) DL Station Leave: YES/NO (Please tick)

From (mention date): 9.10.23 To (mention date): 14.10.23 No. of Days: 6

Purpose of Leave: To attend Short-Term Faculty Training Prog

Address and Phone No. during Leave Period: Vac - MMTTC,
Assam University, Guwahati - 14 93657-69331

Signature of Employee: [Signature] Signature of Head of Department: [Signature]

Leave Sanctioned/ Not Sanctioned Signature of Sanctioning Authority: [Signature]

Signature of Dealing Assistant in charge of Leave Record Maintenance: _____

NB: Copies of all relevant documents wherever required must be enclosed with this application

To,
The Principal
Pragjyotish College
Santipur, Guwahati- 781009

Date: 11/11/2023

Subject: Request for Attending Refresher Course

Respected Sir,

With reference to the subject cited above, I would like to attend a Refresher Course on 'Northeast Languages, Literature and Cultural Studies' from 08-12-2023 to 21-12-2023 at UGC-Malaviya Mission Teacher Training Centre (Formerly known as UGC-HRDC), Gauhati University: Guwahati-781014 which is required for my academic progress. I have been selected to attend the said course and therefore, request you to allow me attend the same. In this regard, I would request you to kindly provide a No Objection Certificate to fulfill the requirements of the course.

I am attaching herewith the selected list of candidates for your kind perusal and necessary action.

I would be highly obliged if you can consider my application.

Yours sincerely,
Dr. Gangotri Bhuyan
Assistant Professor
Department of Anthropology
Pragjyotish College
Email: gangotri@pragjyotishcollege.ac.in
Mobile: 8721955070

Attached:
1. List of Selected Candidates

*Approved -
Memo No 11/11/2023*

Principal
Pragjyotish College
Guwahati-781009

To,
The Principal
Pragjyotish College
Guwahati-09

Dated: 07/09/2023

Through the HOD, Chemistry

Sub: Application for Permission to take Selected Honours Students to IIT Guwahati for a workshop

Sir,

With due respect I have the honor to inform you Department of Chemistry, IIT Guwahati is organizing an **one-day workshop on Advanced Scientific Instruments** on 08th September 2023 for undergraduate students. I have applied for the same and received permission to take 27 students. Therefore I request you to allow me to take them to attend the same. The list of students willing to attend the workshop is attached herewith, I also request you to allow me **and Dr. Priyashree Borthokur** to take Duty Leave to guide the students to IIT Guwahati.

Thanking you.

Regards
Saitanya Kr Bharadwaj
Assistant Professor
Department of Chemistry
Pragjyotish College
Guwahati-09

*Forwarded
11/11/2023*

*Forwarded
8/08/2023*

*Dr. Shama Choudhury
Associate Professor
Department of Mathematics
Pragjyotish College, Guwahati-09*

*Forwarded
07/09/23*

Institution provides institutional email ids of the faculty members



প্রাগজ্যোতিষ মহাবিদ্যালয়
PRAGJYOTISH COLLEGE
 Accredited by NAAC with B Grade (3rd Cycle), under Revised
 Accreditation Framework (RAF)

Name of the Teacher	Designation	Department	E-mail id
Dr. Gangotri Bhuyan	Assistant professor	Anthropology	gangotri@pragjyotishcollege.ac.in
Dr. Mayuri Borkataky	Assistant professor	Anthropology	mayuriborkataky@pragjyotishcollege.ac.in
Dr. Surabhi Madhuri Gogoi	Assistant professor	Assamese	surabhi@pragjyotishcollege.ac.in
Dr. Indrani Kalita	Associate professor	Assamese	indrani@pragjyotishcollege.ac.in
Dr. Jyotirmoy Sengupta	Associate professor	Bengali	jyotirmoysg@pragjyotishcollege.ac.in
Dr. Ranjan Kumar Bora	Associate professor	Botany	ranjankrbora@pragjyotishcollege.ac.in
Dr. Reena B. Kalita	Associate professor	Botany	reenabkalita@pragjyotishcollege.ac.in
Bamali Das	Assistant professor	Botany	barnalidas@pragjyotishcollege.ac.in
Deepika Borah	Assistant professor	Botany	deepikaborah@pragjyotishcollege.ac.in
Dr. Himadri Saikia	Assistant professor	Botany	himadrisaikia@pragjyotishcollege.ac.in
Dr. Amit Kumar Pradhan	Assistant professor	Botany	akpradhan@pragjyotishcollege.ac.in
Saroj Sarma	Associate professor	Chemistry	masunalmed@pragjyotishcollege.ac.in
Dr. Masum Ahmed	Assistant professor	Economics	samasaroj@pragjyotishcollege.ac.in
Dr. Ira Das	Associate professor	Economics	iradas@pragjyotishcollege.ac.in
Anupriya Saikia	Assistant professor	Education	anupriyasaikia@pragjyotishcollege.ac.in
Dr. Mridusmita Devi	Assistant professor	Education	mridusmitadevi@pragjyotishcollege.ac.in
Dr. Avijit Kumar Dutta	Assistant professor	English	abhijitdutta@pragjyotishcollege.ac.in
Lalitanzuol Khawbung	Assistant professor	English	lalitanzuol@pragjyotishcollege.ac.in
Monali Ghosh Dastider	Assistant professor	English	monalighosh@pragjyotishcollege.ac.in
Priyanka Samah	Associate professor	English	priyankasamah@pragjyotishcollege.ac.in
Dr. Jyoti Prasad Das	Assistant professor	Geography	jpdas@pragjyotishcollege.ac.in
Dr. Krishna Das	Assistant professor	Geography	krishna@pragjyotishcollege.ac.in
Dr. Bhriгу Kumar Nath	Assistant professor	Geography	bhriгу@pragjyotishcollege.ac.in
Pradip Chandra Kalita	Assistant professor	Geography	pradip@pragjyotishcollege.ac.in
Dr. Dipali Baruah	Associate professor	Geography	dipali@pragjyotishcollege.ac.in
Dr. Mridul Rabha	Assistant professor	Geology	mridulrabha@pragjyotishcollege.ac.in
Dr. Manjit Kumar Mazumdar	Associate professor	Geology	manjit@pragjyotishcollege.ac.in
Dr. Priyam Barthakur	Associate professor	Geology	priyambarthakur@pragjyotishcollege.ac.in
Suman Saikia	Assistant professor	Geology	sumansaikia@pragjyotishcollege.ac.in
Dr. Priti Baishya	Assistant professor	Hindi	pritibaishya@pragjyotishcollege.ac.in
Dr. Nandita Rajbangshi	Assistant professor	Hindi	nandita@pragjyotishcollege.ac.in
Dr. Chandana Sarma	Assistant professor	Hindi	chandana@pragjyotishcollege.ac.in
Pankhi Senapati	Assistant professor	Hindi	pankhi@pragjyotishcollege.ac.in
Bishwajyoti Dev Mahanta	Associate professor	History	bishwa@pragjyotishcollege.ac.in
Badan Chandra Mahanta	Associate Professor	History	badanmahanta@pragjyotishcollege.ac.in
Dr. Gargee Sharmah	Assistant professor	History	gargee@pragjyotishcollege.ac.in
Dr. Nandini Sarma	Associate professor	History	nandini@pragjyotishcollege.ac.in
Dr. Jibonjyoti Buragohain	Assistant professor	Mathematics	jibonjyoti@pragjyotishcollege.ac.in
Dr. Shampa Choudhury	Associate professor	Mathematics	cshampa@pragjyotishcollege.ac.in
Niva Deka	Associate professor	Philosophy	nivadeka@pragjyotishcollege.ac.in
Dr. Kabita Doloi	Assistant professor	Philosophy	kabitadoloi@pragjyotishcollege.ac.in
Dr. Parmita Chowdhury	Assistant professor	Philosophy	parmitachowdhury@pragjyotishcollege.ac.in
Dr. Kalyani Devi	Assistant professor	Philosophy	kalyani@pragjyotishcollege.ac.in
Dr. Samrat Dey	Assistant professor	Physics	samratdey@pragjyotishcollege.ac.in
Saumar Rajkhowa	Associate professor	Physics	saumarrajkhowa@pragjyotishcollege.ac.in
Dr. Ranjan Kalita	Assistant professor	Physics	ranjankalita@pragjyotishcollege.ac.in
Mr. Sun Gogoi	Assistant professor	Political Science	sungogoi@pragjyotishcollege.ac.in
Dr. Sabrina Iqbal Sircar	Assistant professor	Political Science	sabrina@pragjyotishcollege.ac.in
Nabadeep Das	Associate professor	Political Science	nabadeepdas@pragjyotishcollege.ac.in
Nibedita Devi	Associate professor	Sanskrit	nibeditadevi@pragjyotishcollege.ac.in
Dr. Anjali Devi	Assistant professor	Sanskrit	anjali@pragjyotishcollege.ac.in
Dr. Pranita Goswami	Associate professor	Statistics	statistics@pragjyotishcollege.ac.in

Educational Google Workspace of the faculty members

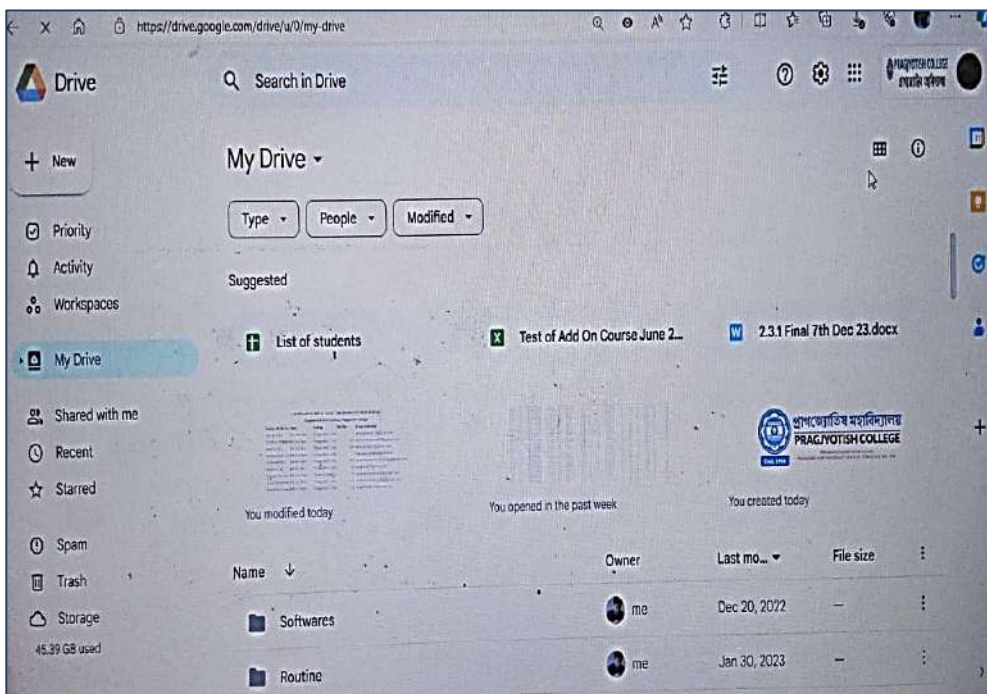
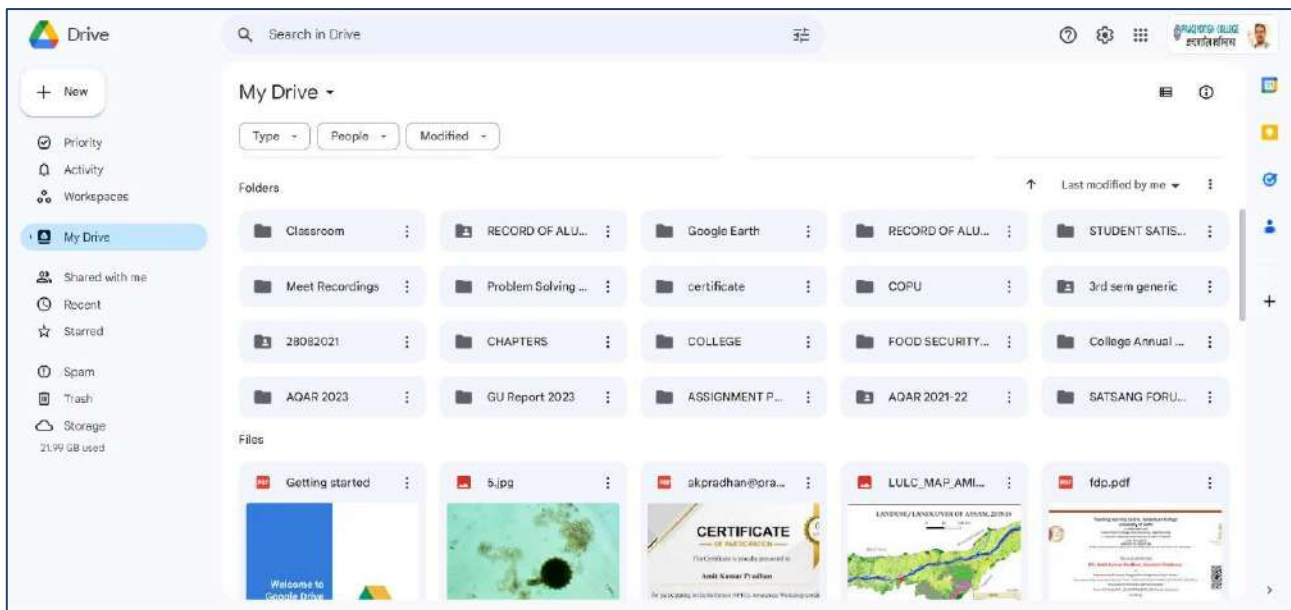
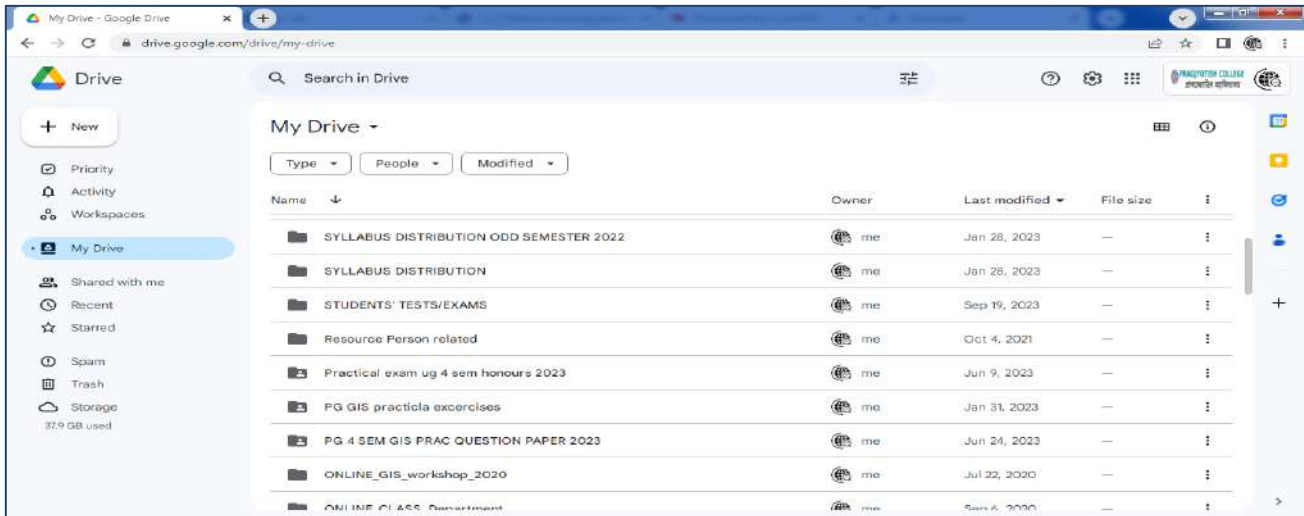

ICT TOOLS FOR EFFECTIVE TEACHING LEARNING

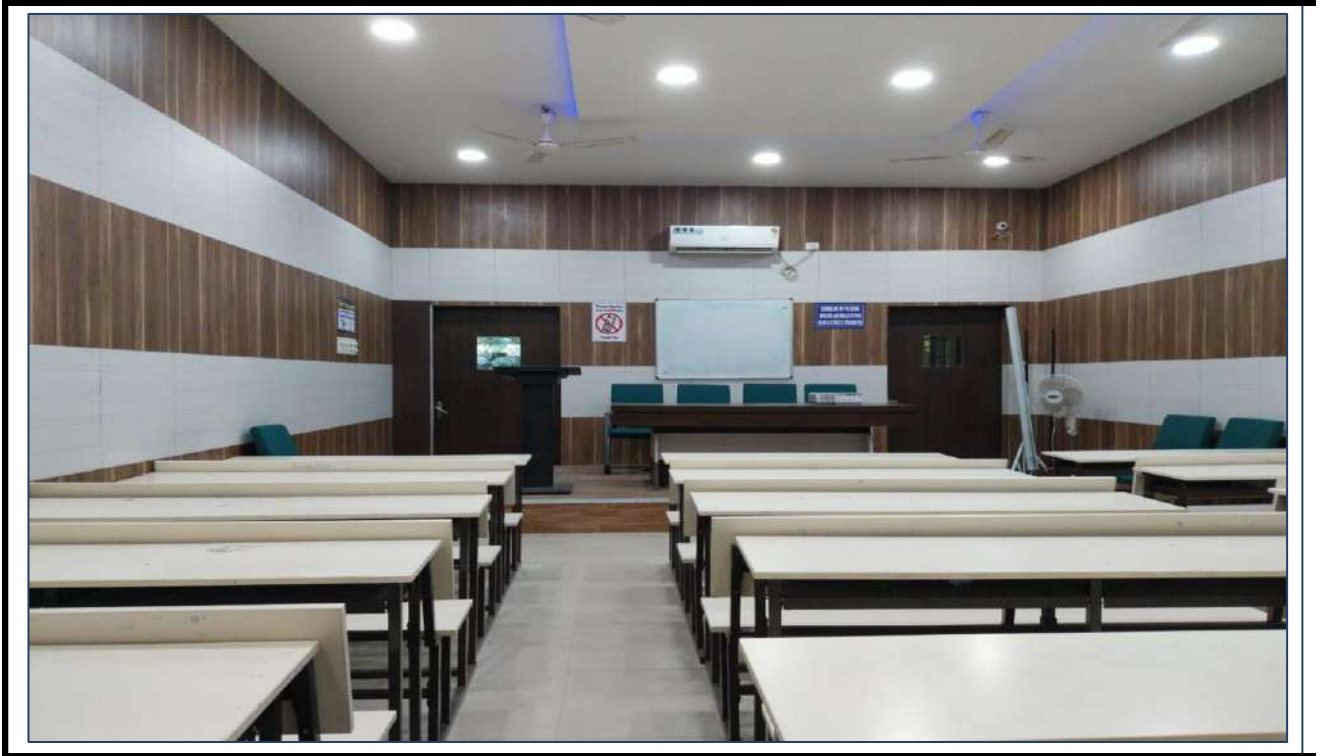

ICT ENABLED CLASS ROOM IN THE DEPARTMENT OF ASSAMESE



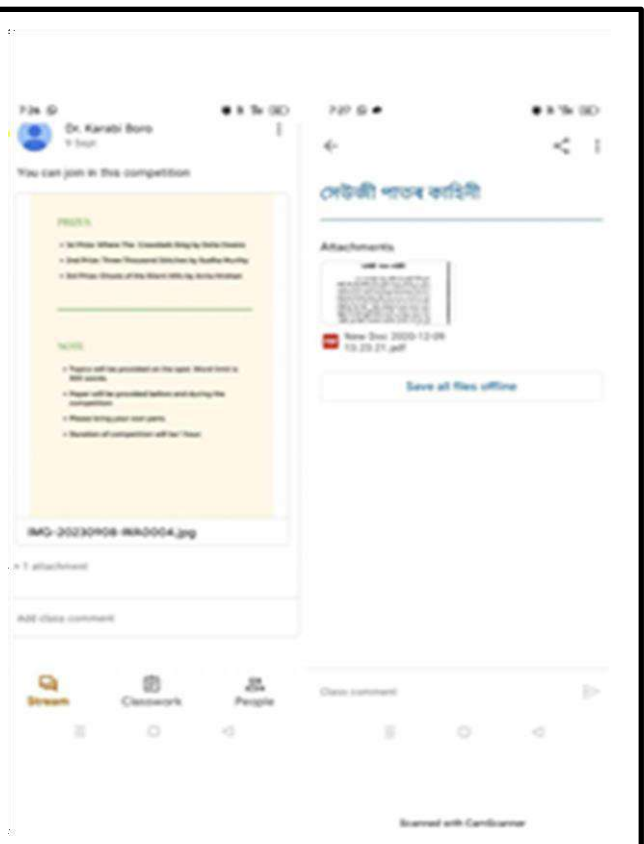
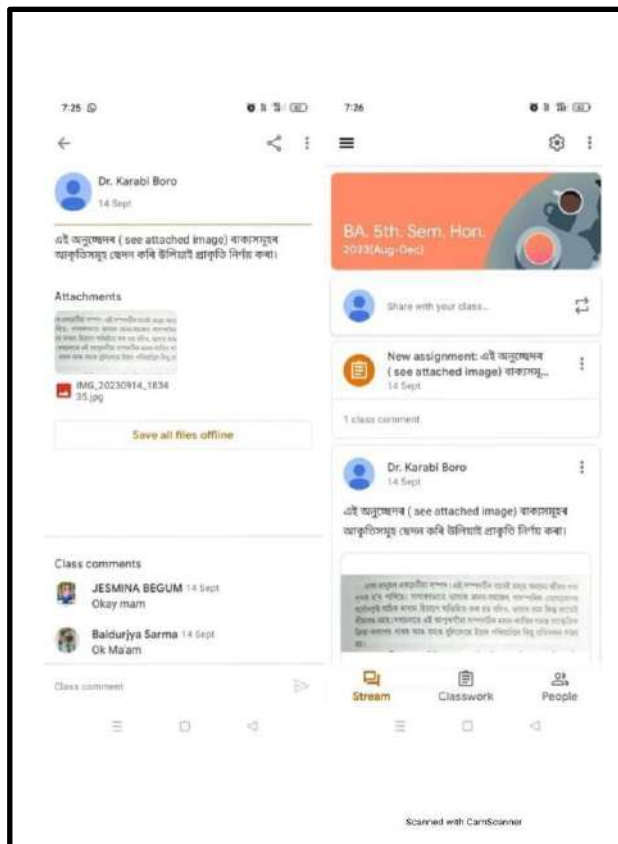
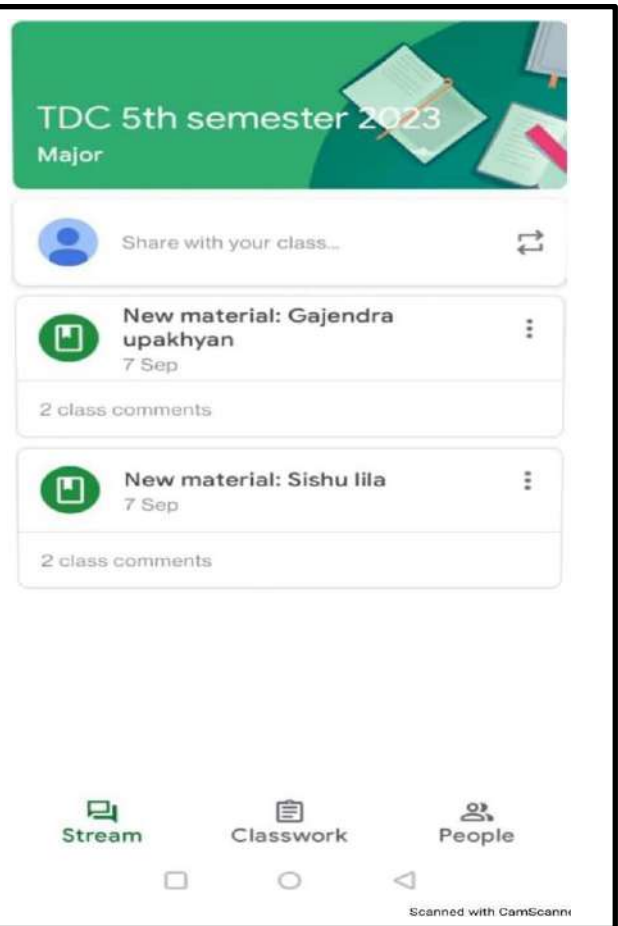
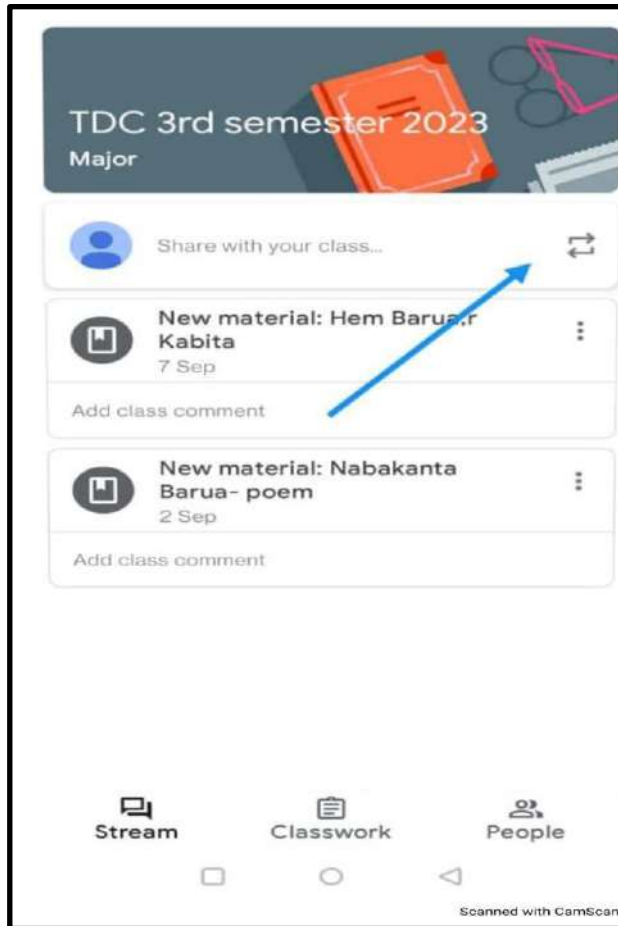

STUDY MATERIALS SHARED WITH MAJOR STUDENTS THROUGH GOOGLE CLASSROOM

4:09 53%

BA 1st Sem(M)-NEP...

Teachers

Dr. Kalpana Talukdar

Students

Aman Ramchiary
Ambika Das
Amlan jyoti Deka
Anisha Parbin
Bipasha Neogi
Rinkal Das

Stream Classwork People

Add class comment

New material: भुलीया डाउबीया 7 Sept

Add class comment

New material: गुज्जगलि 29 Aug

Add class comment

Dr. Kalpana Talukdar 28 Aug

BA 3rd Sem(H)-2023

1 attachment

Add class comment

Stream Classwork People

D5-H-23-Dr. Kalpana
Group · 37 participants

Group call Add Search

Add group description
Created by You, 14/11/2022

Media, links, and docs 23 >

Scanned with CamScanner

4:52 25%

BA5th(23)Sem

Teachers

Dr. Surabhi Madhuri Gogoi

Classmates

Ankur deka
Baidurjya Sarma
Bandita Das
Bidisha Dauka

Stream Classwork People

Scanned with CamScanner

4:52 25%

2023,TDC 3rd Sem

Teachers

Dr. Surabhi Madhuri Gogoi

Classmates

Bhanita Baishya
Biswajit Chaudhury
Gautam Kalita
Manshi Medhi

Stream Classwork People

Scanned with CamScanner

4:51 25%

TDC 1st Sem-20...

Teachers

Dr. Surabhi Madhuri Gogoi

Students

Aman Ramchiary
Amlan jyoti Deka
Anisha Parbin
Bipasha Neogi

Stream Classwork People

Scanned with CamScanner

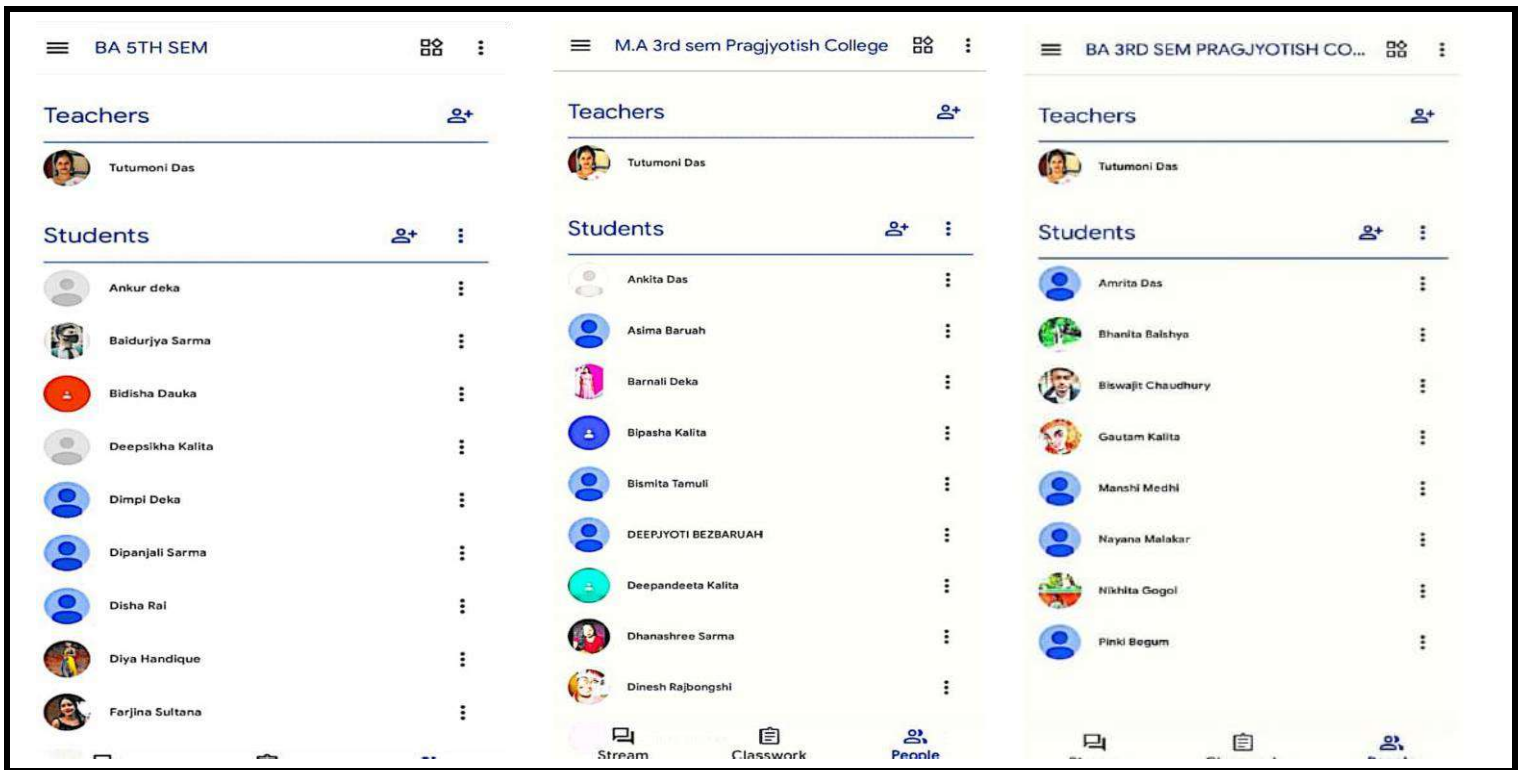

Figure: The Google classrooms were set up for the students belonging to CBCS and Non-CBCS courses for sharing of Study Materials, educational videos, assigning projects, conducting online tests and submission of Project Reports Department of Assamese



Students are familiarized with projector as a teaching tool by Department of Botany



Zoom platform is used as a medium for online classes
By Department of Bengali



ICT Enabled Class Room of Department of Chemistry

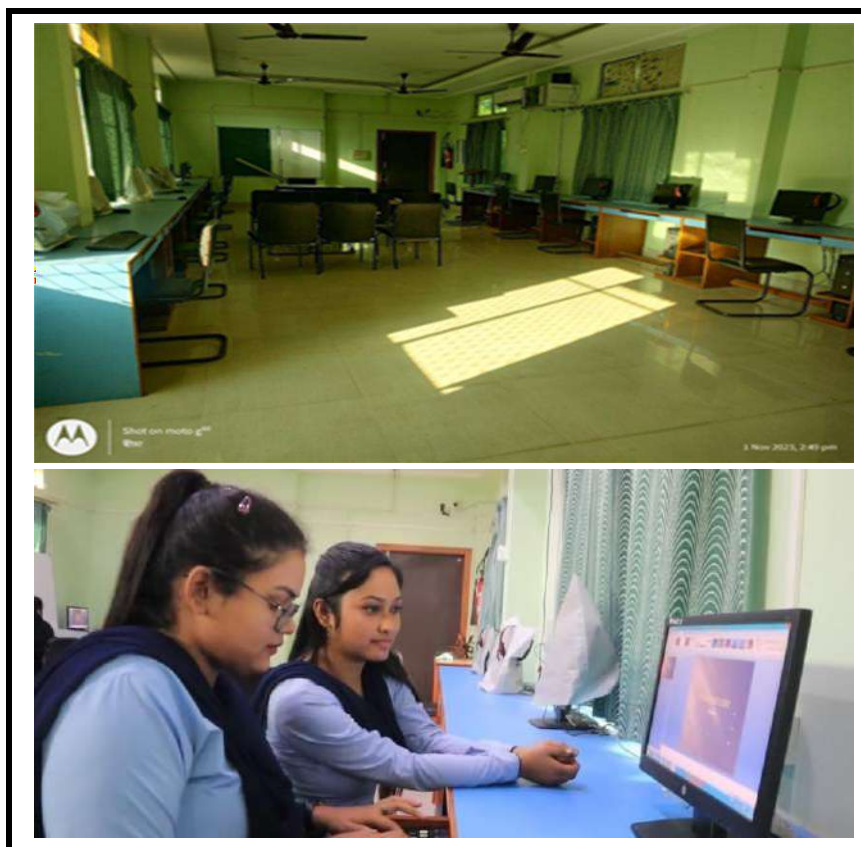

Use of computers by the students in the language lab of the Department of English

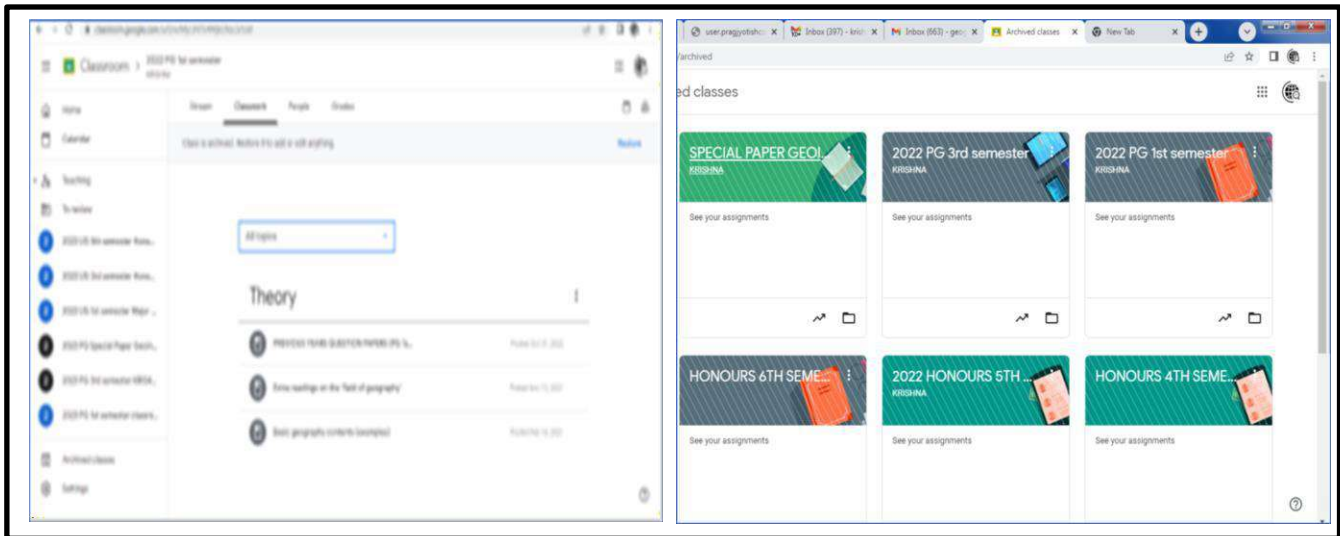

Google class room used to share study materials and computers are used in the GIS laboratory by Department of Geography

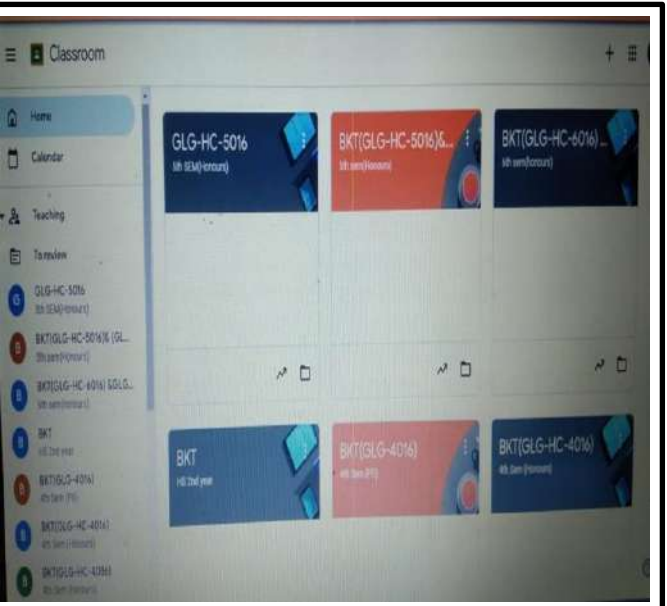

Smart classroom and Google class room are used as teaching tools by the Department of Geology

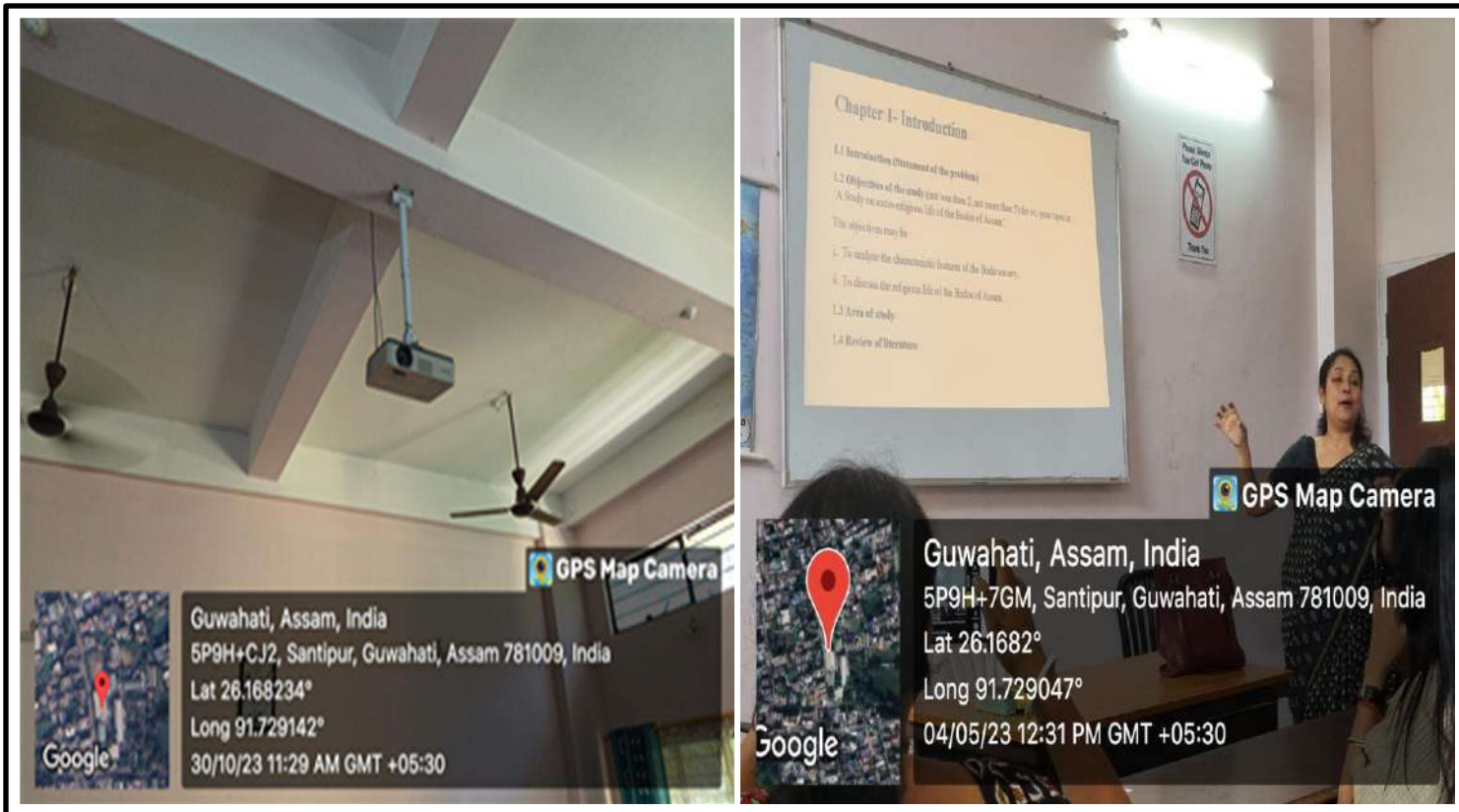

LCD Projectors are used as teaching aid by Department of History

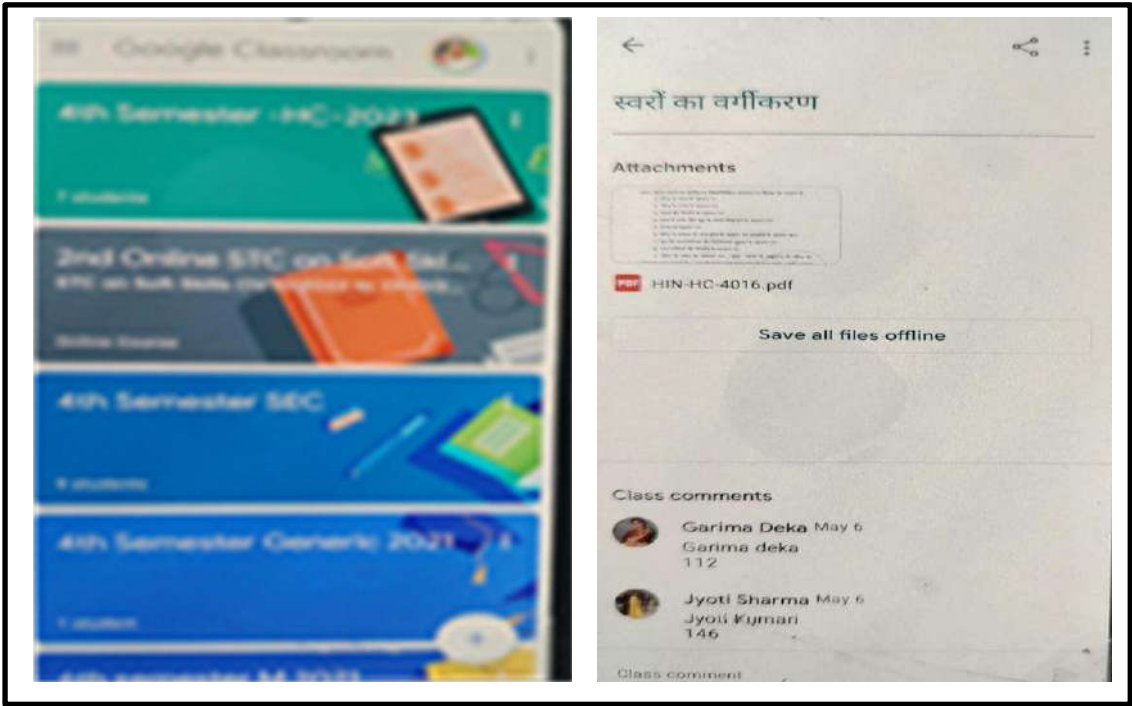

Google class room is used to share study materials by Department of Hindi



Projector is used as tool for effective teaching by the Department of Mathematics



ICT enabled Class Room of department of MTM



Use of Projector and Computers in the Class Room by Department of Physics

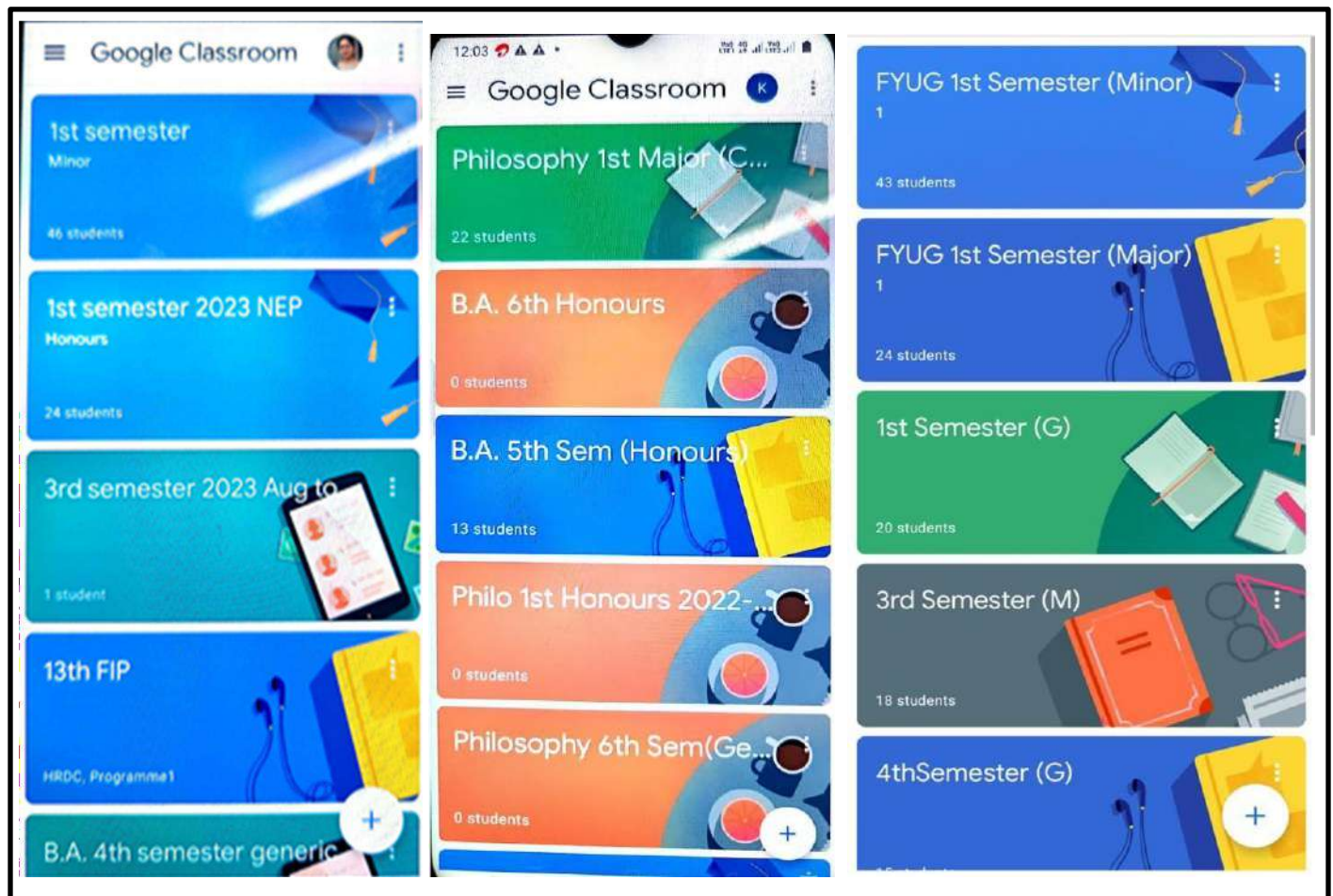

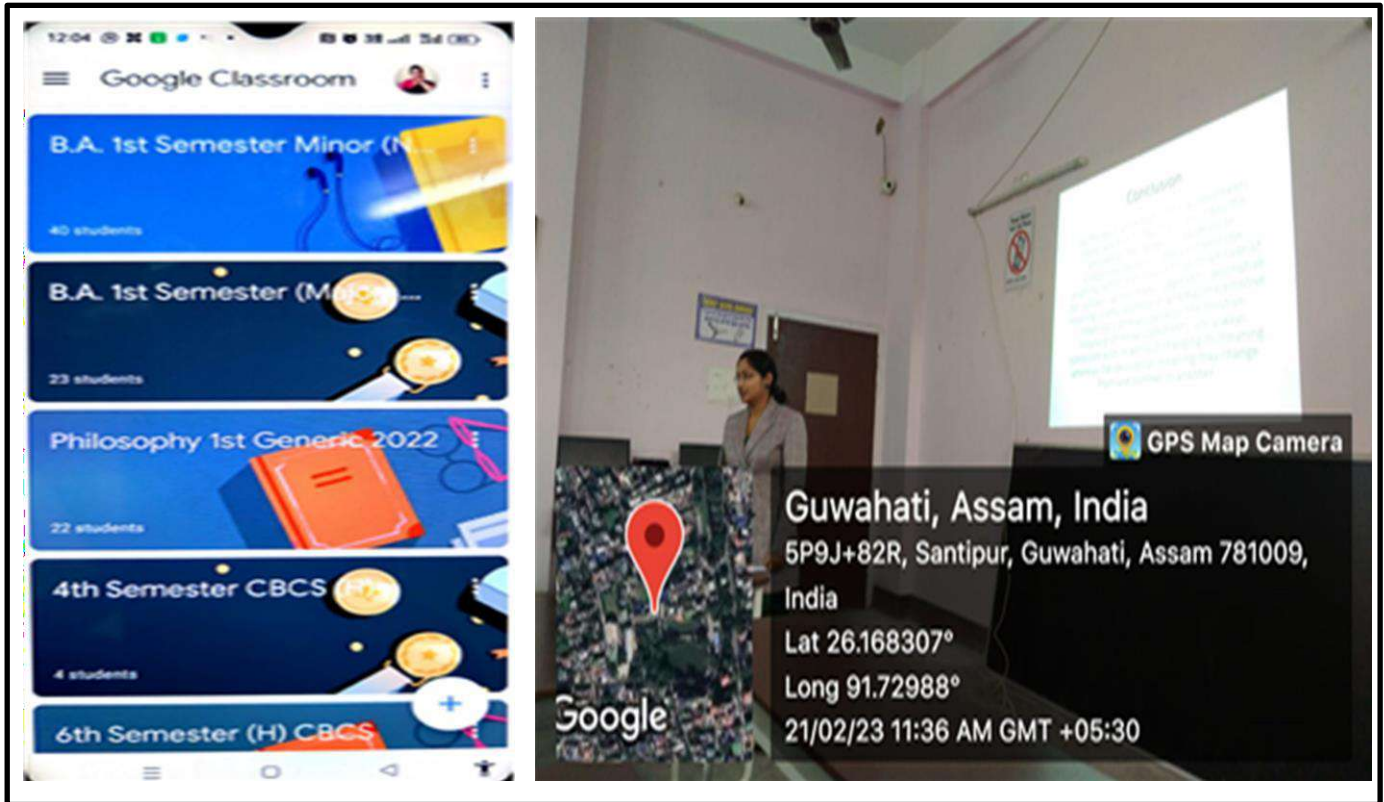

Google Class Room and Projectors used as teaching tools by the Department of Philosophy

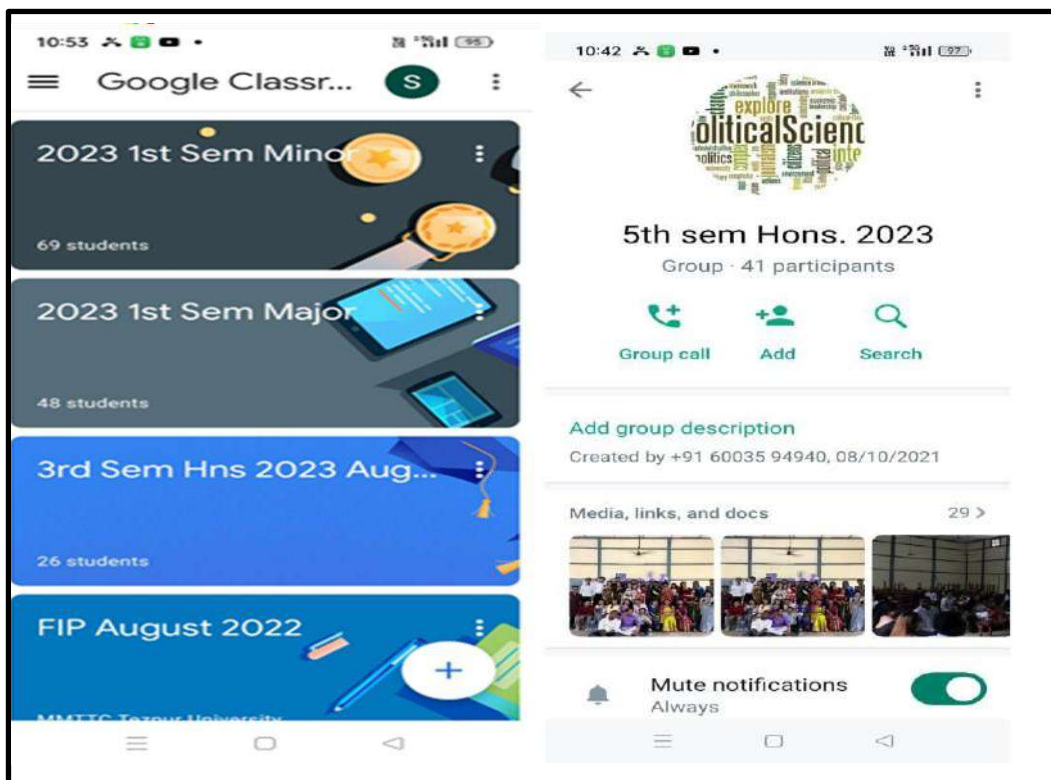

Google Class Room is used to share class-notes, e-books, ppts, etc. by Department of Political Science



Projector is used as teaching tool and Google Class Room is used for sharing study materials by the Department of Statistics



ICT Class Room used by the Department of Zoology

GEOGRAPHY STUDENTS PREPARED MAPS UTILIZING GIS APPLICATIONS IN PRACTICAL CLASSES

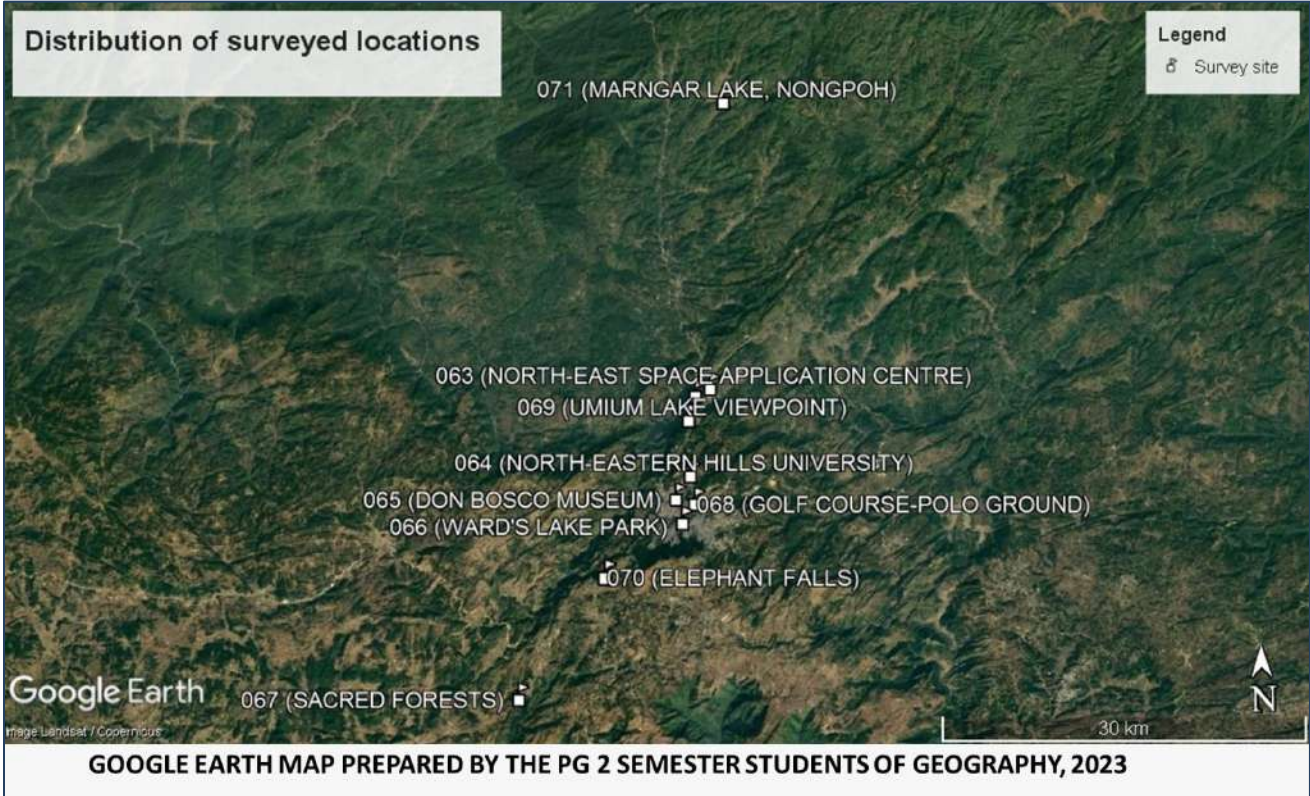
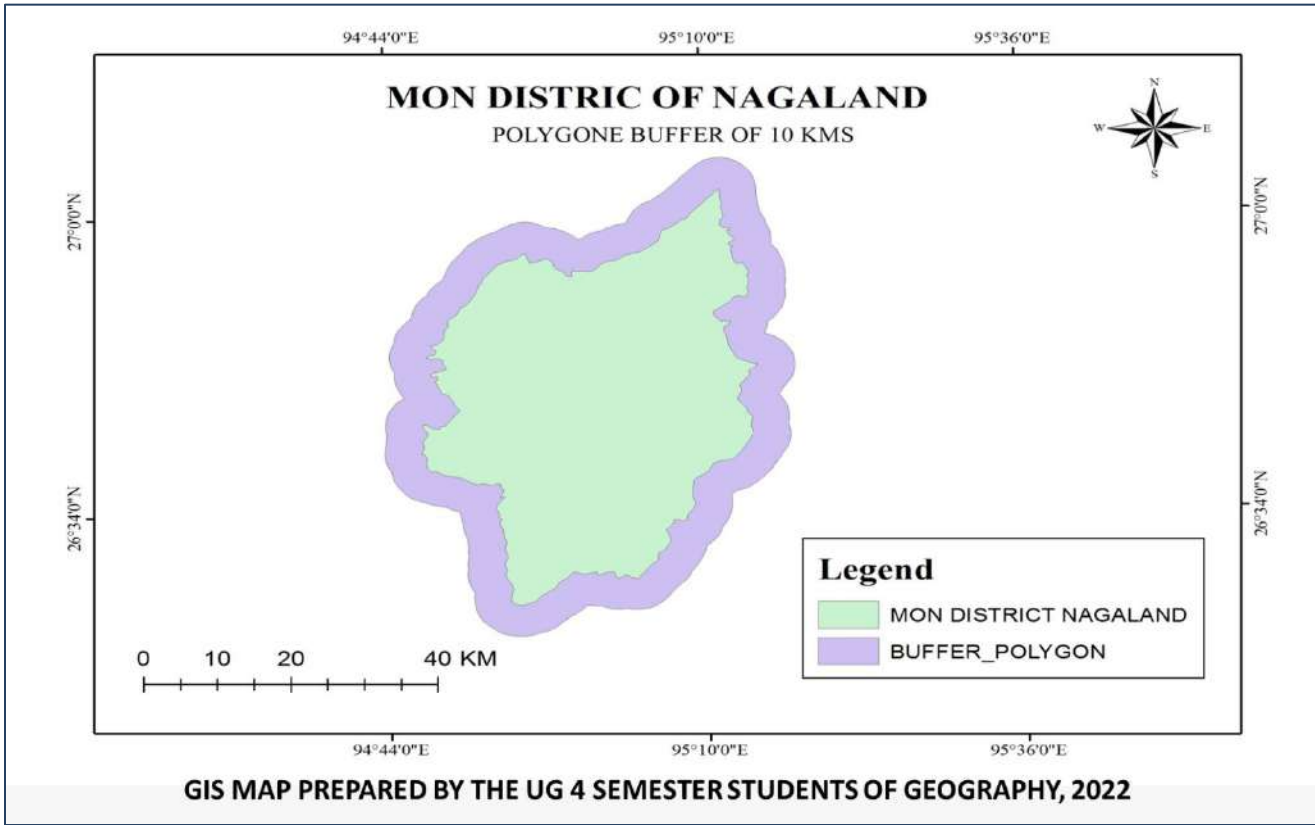

STATISTICS STUDENTS PREPARED DIAGRAM UTILIZING R APPLICATIONS IN PRACTICAL CLASSES

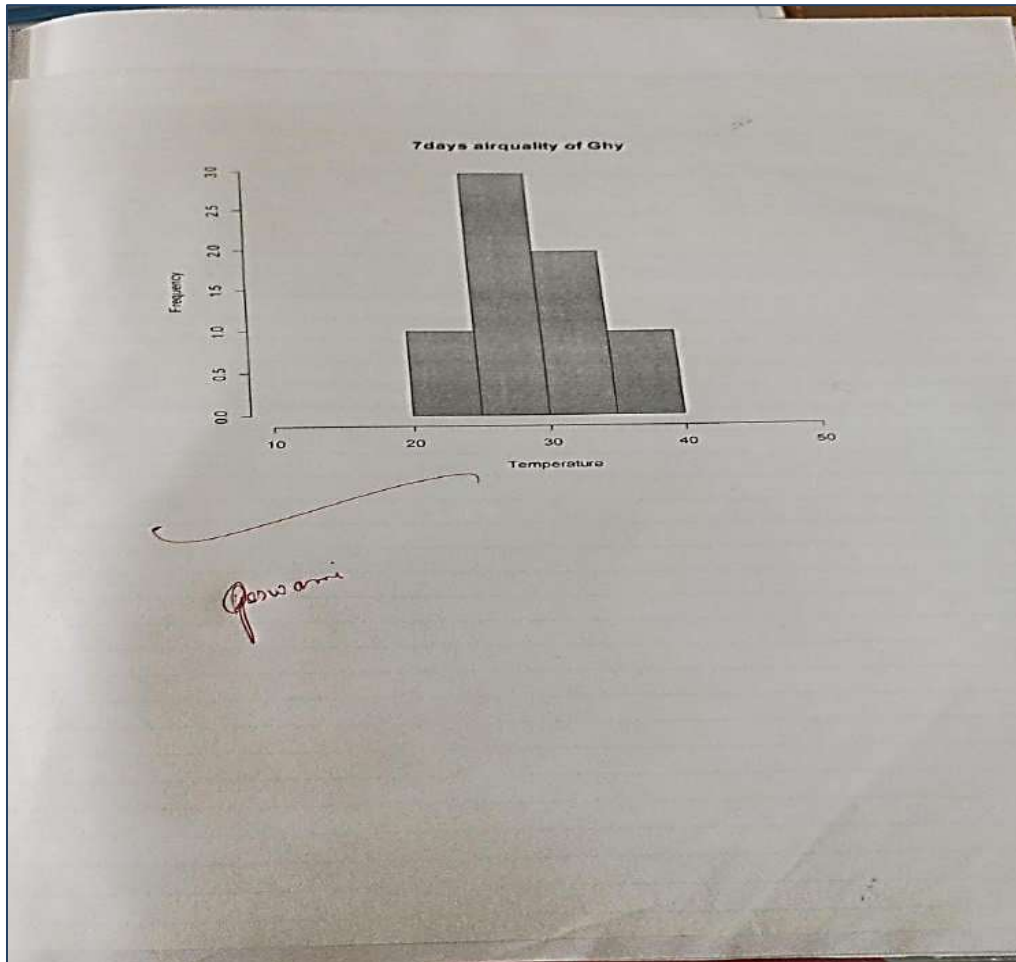

STATISTICS STUDENTS PREPARED DIAGRAM UTILIZING SPSS APPLICATIONS IN PRACTICAL CLASSES

```
#include <stdio.h>
#include <stdlib.h>
#define ELEMENTS 6
int values[] = { 40, 10, 100, 90, 20, 25 };
int compare (const void * a, const void * b)
{
    return ( *(int*)a - *(int*)b );
}
int main ()
{
    int n;
    qsort (values, ELEMENTS, sizeof(int), compare);
    for (n=0; n<ELEMENTS; n++)
    { printf ("%d ", values[n]); }
    printf ("median=%d ", values[ELEMENTS/2]);
    return 0;
}
```

10 20 25 40 90 100 median=40

Process exited after 0.01764 seconds with return value 0
Press any key to continue . . .

Poowani

MATHEMATICS STUDENTS COMPLETED EXERCISE UTILIZING SCILAB APPLICATIONS IN PRACTICAL CLASSES

• **Plotting the graph of some algebraic and trigonometric functions:**

1. Plot the graph of $f(x) = ax$

```

x=0:0.3:30
a1=4
a2=2
a3=8
y1=a1*x
y2=a2*x
y3=a3*x
plot(x,y1,"-", x,y2,"-", x,y3, "-")
xtitle("a plot of ax curve")
xlabel("values of x")
ylabel("values of y(=ax)")
legend(["$y1=a1x$","$y2=a2x$","$y3=a3x$"],pos=5)
    
```

2. Plotting the graph of greatest integer function ($f(x) = [x]$):

```

x=0:0.1:10.7
y=floor(x)
plot(x,y,"+")
xgrid
    
```

xtitle("a plot of greatest integer or floor function")
 xlabel("values of x")
 ylabel("values of y(=[x])")
 legend(["[x]"],pos=5)

ECONOMICS STUDENTS PREPARED STATISTICAL DIAGRAM UTILIZING SPREADSHEET APPLICATIONS IN PRACTICAL CLASSES

Slide 17 of 33

Figure 2: Training provided by the government in fish farming

Region	Yes (%)	No (%)
South Kamrup	12.90%	87.10%
Gohpur	0%	100%

- Our data shows that only 12.90 percent of the South Kamrup region got the same while no one from the Gohpur area received any formal training on this aspect. We then enquired about the subsidy or monetary benefit schemes penetration.

Figure 3: Access to subsidy or monetary help from the government.

Region	Yes (%)	No (%)
Soth Kamrup	25.80%	74.20%
Gohpur	3.30%	96.70%

PHYSICS STUDENTS PREPARED EXERCISES UTILIZING QUCS APPLICATIONS IN PRACTICAL CLASSES

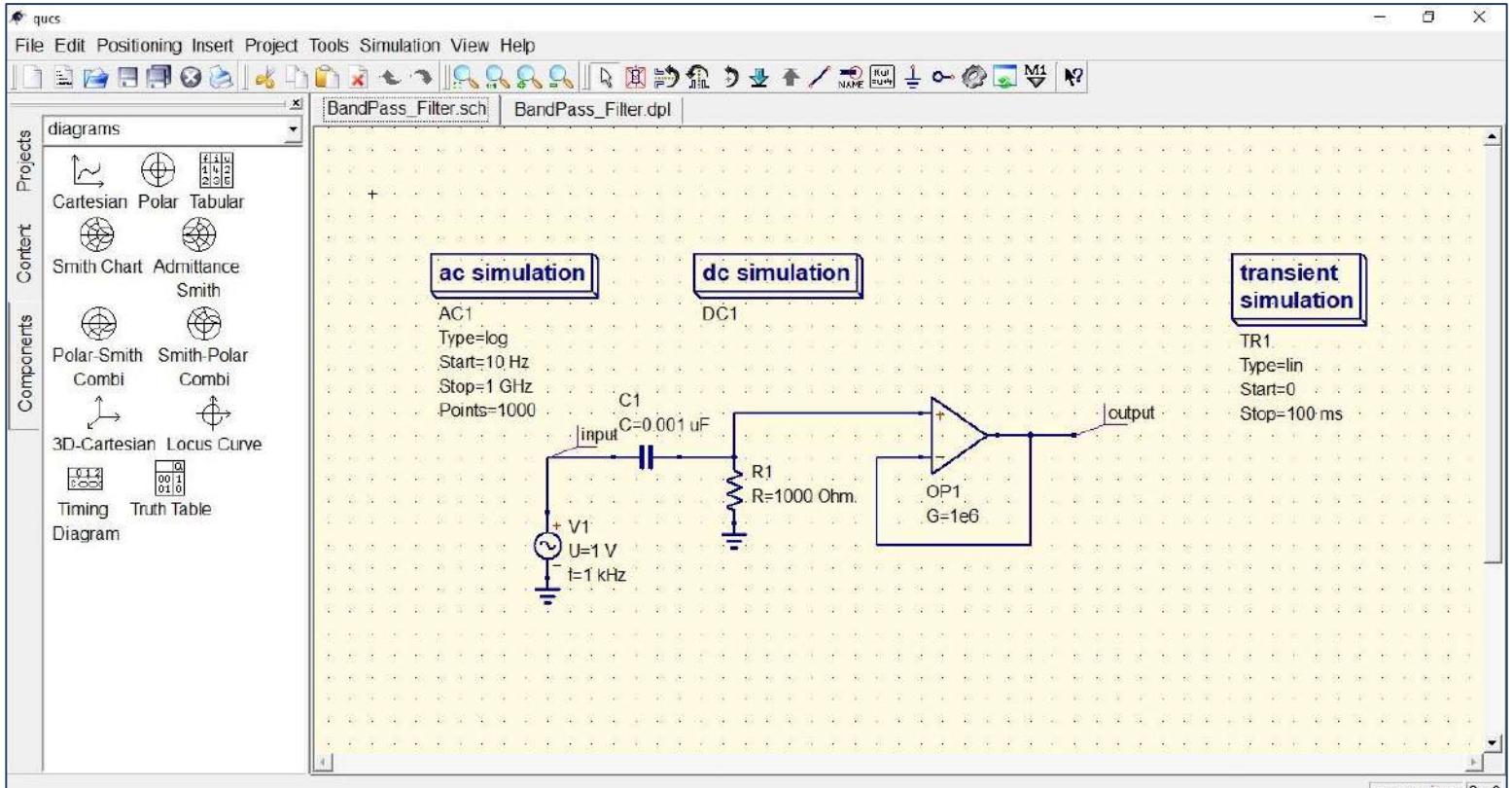
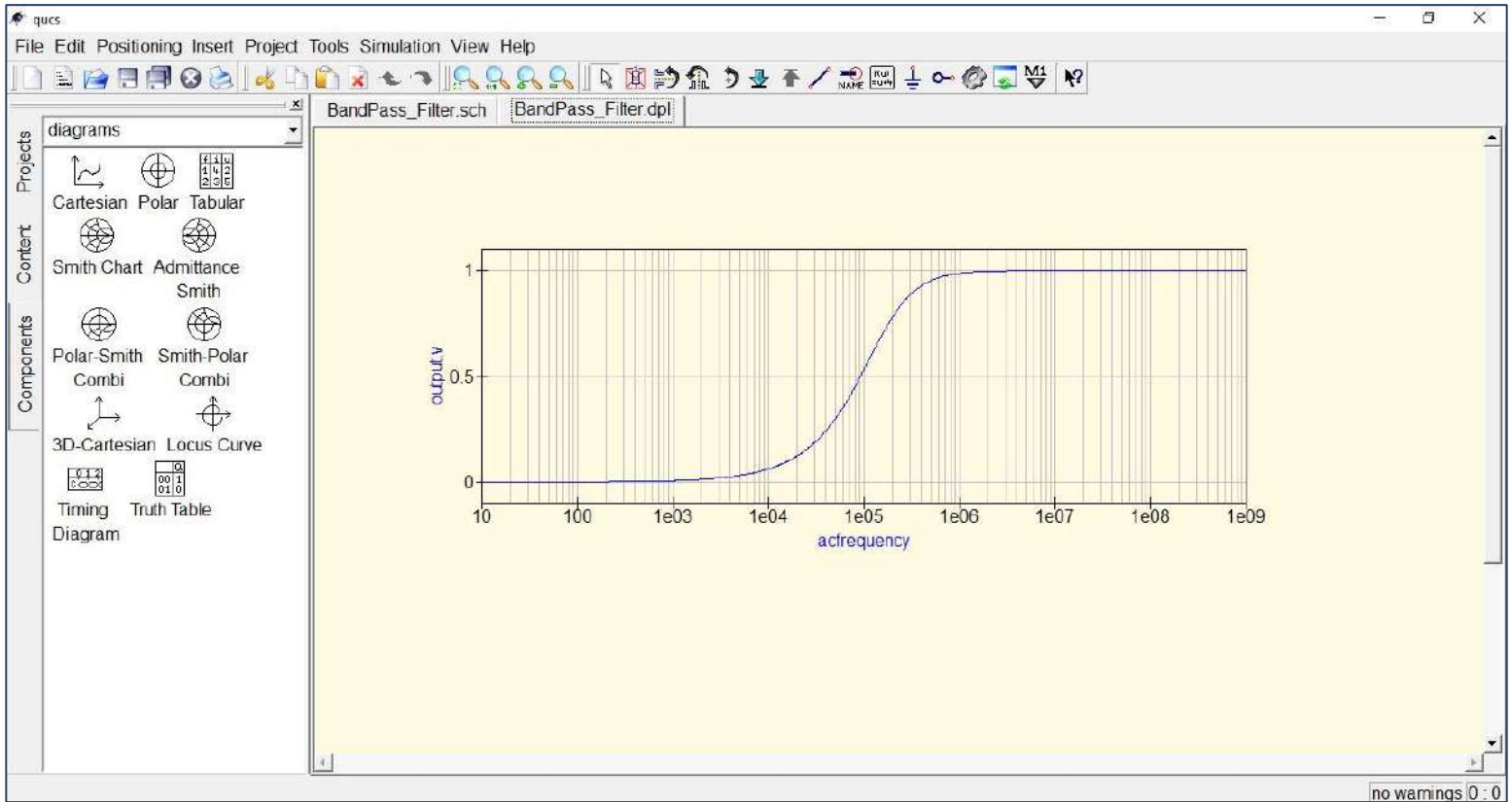

ICT TOOLS INCORPORATED BY TEACHERS FOR EVALUATING STUDENTS THROUGH ONLINE QUIZ AND MCQS, SUBMISSION OF ASSIGNMENTS, AND ONLINE STUDENT SEMINARS AND WEBINARS WITH PROMINENT RESOURCE PERSONS

docs.google.com/form

CLASS TEST

Questions Responses **172** Settings

CLASS TEST

CLASS TEST (B.COM 1ST SEM)
DATE:-22/08/2023 TOTAL MARKS :50 : TIME: 1hr

NAME OF THE STUDENT *

Short answer text

ROLLNO & EMAIL ID *

Short answer text

1. Who is Father of Scientific Management ? *

(A) Henry Fayol

9:53

Form Design

BA, 5th. Sem. Honours

Class test to evaluate attainment of course outcome

Short Answer

Instruction for quiz maker : For fields requiring response but do not have marks leave score to zero.

নাম

Answer explanation shown after test (Optional)

Score: - 0 +

Short Answer

Instruction for quiz maker : For fields requiring response but do not have marks leave score to zero.

Email

Answer explanation shown after test (Optional)

ADD ITEM

Marks - 12

নাম

Baidurjya Sharma
Marks: 0.0

Email

baidurjyasarma415@gmail.com
Marks: 0.0

হবিস্চন্দ্র উপাখ্যান' কাব্যখনর বচক কোন?

শংকরদেব
Marks: 2.0

গ্রীক শব্দ 'grammata' শব্দটোর অর্থ কি?

আখর জনা তত্ত্ব
Marks: 2.0

লঘোদর কার নাম?

গণেশ্বর
Marks: 2.0

FYUGP 1st Sem (Major)

Share with your class...

New assignment: Assignment
Aug 24

Add class comment

Florina Thakuria
Aug 21

Submit it or on before 25/08/23

Assigned on 5/8/23

Q1) Write the types of Data

Q2) Write the Definition of population and sample with example.

Questions Responses **23** Settings

Quiz 1 Factors of Production

Form description:

This form is automatically collecting emails from all respondents. Change settings

Your Name: নাম *

Short answer text

Class roll no. ক্লাস রোল নং *

Short answer text

1. A Laptop owned by a teacher is an example of which type of factor of production. এজন্য শিক্ষকের হালিকারনাথীন সেপটিপ হৈছে উৎপাদনর কোন ধরকার উপাদান r উদাহরণ.

Land: ভূমি
 Labour: শ্রম
 Capital: মূলধন
 Organisation: সংগঠক

2. Iron, minerals, coal and plants are examples of which productive resource? লোহা, খনিজ পদার্থ, কয়লা আক উদ্ভিদ কোনটো উৎপাদনশীল সম্পদর উদাহরণ?

Land: ভূমি
 Labour: শ্রম
 Capital: মূলধন
 Organisation: সংগঠক

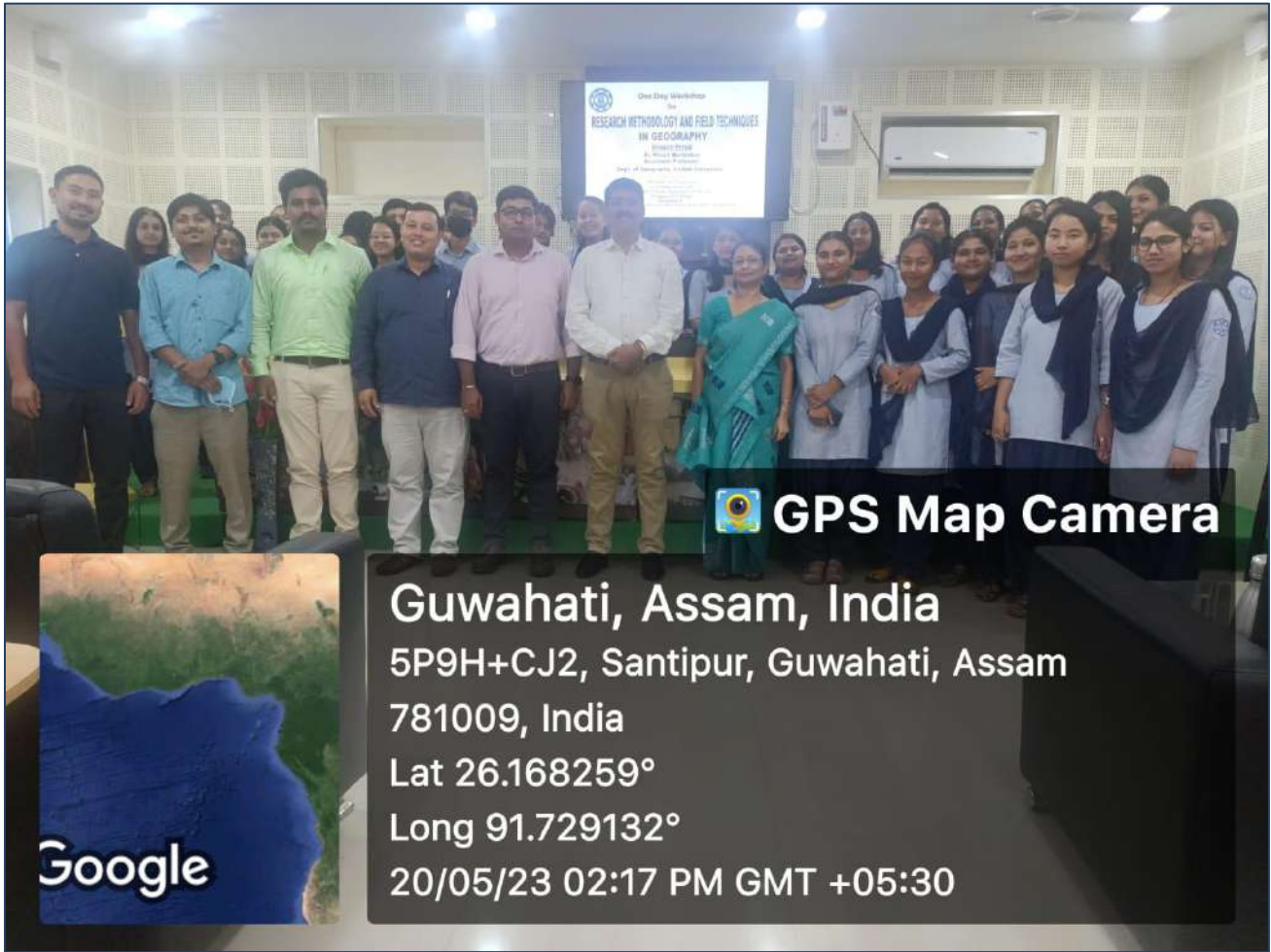

<https://pragiyotishcollege.ac.in/department/GGY/singleevent?eventId=853>